

EXTENSIONS D'ANGLE H2452

AVEC FILEUR SUPPORT ANGLE

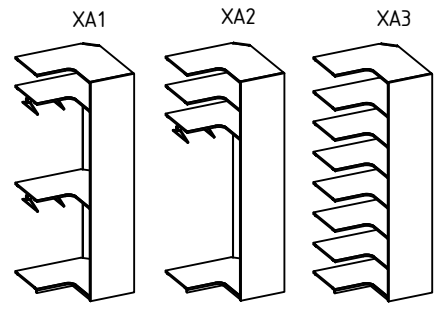

AVEC FOND D'ANGLE

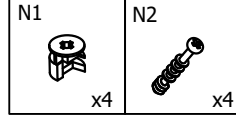
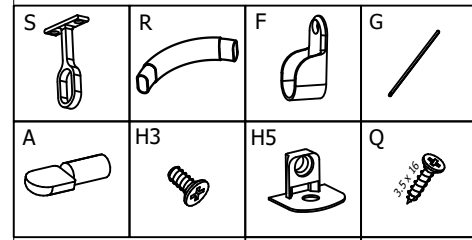
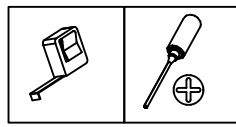
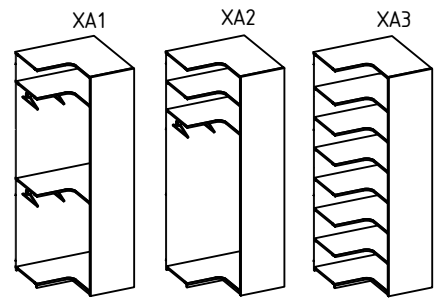

FILEUR SUPPORT ANGLE

TABLETTE FIXE

FOND D'ANGLE

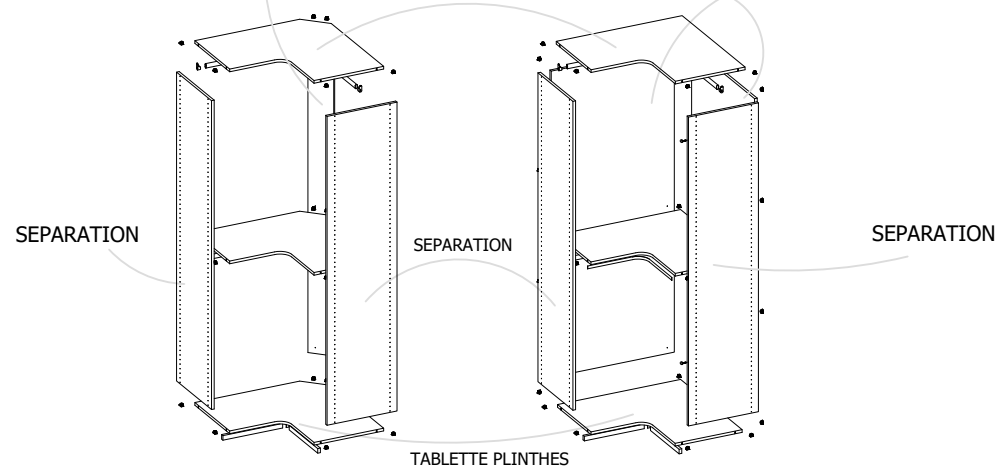

1

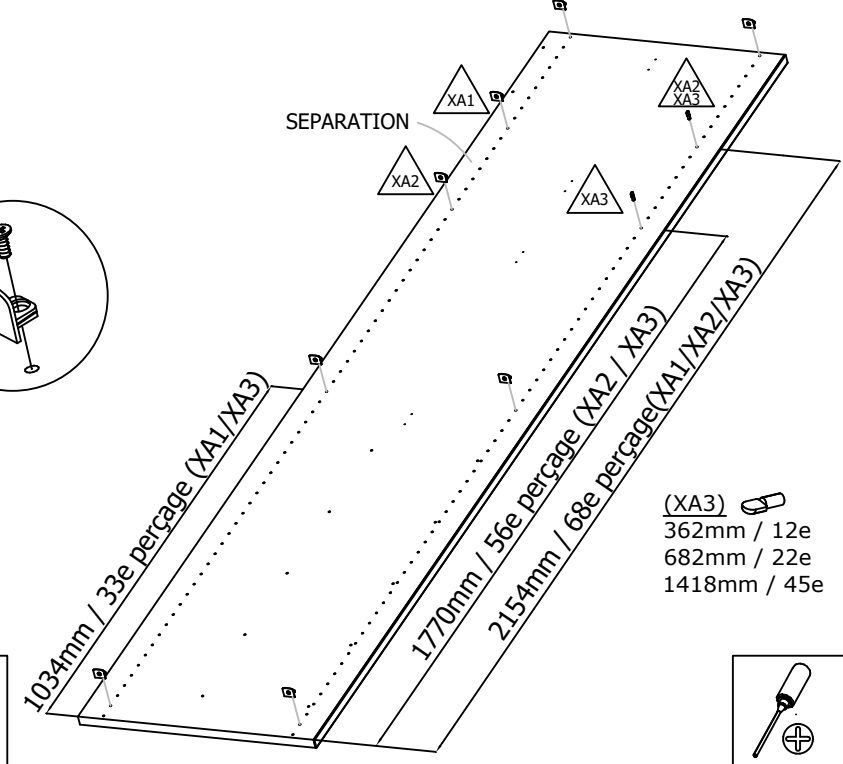
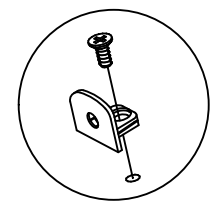

2

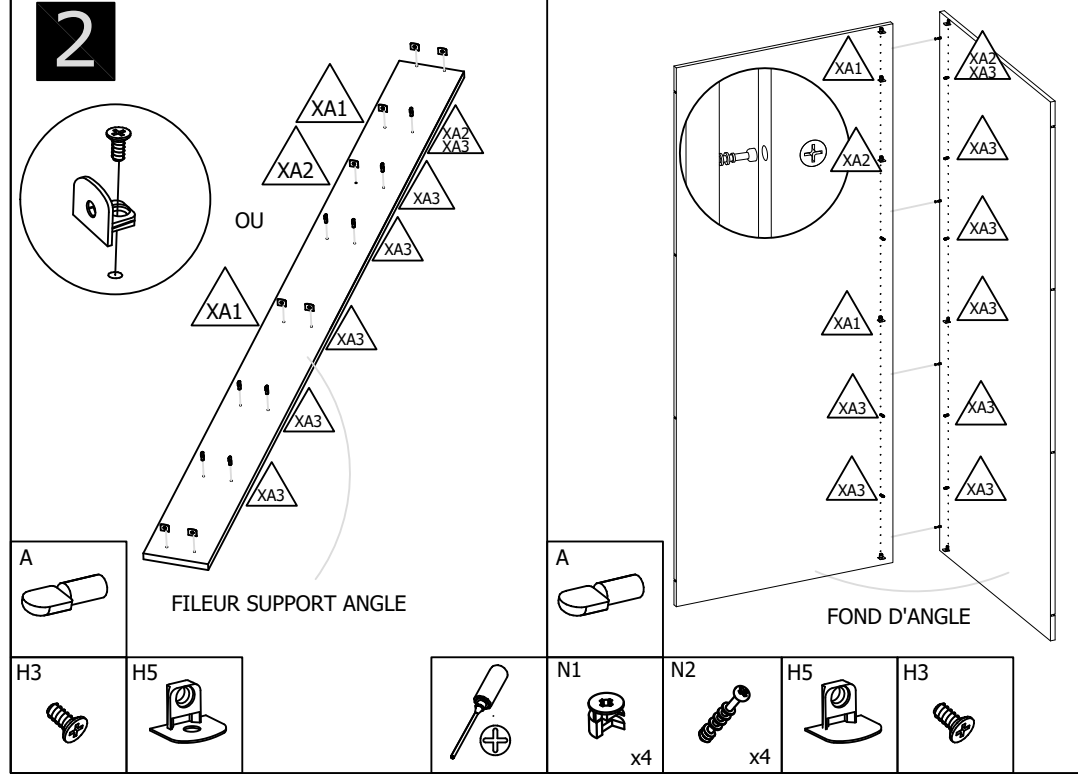
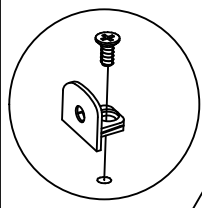

3

FILEUR SUPPORT ANGLE

FOND D'ANGLE

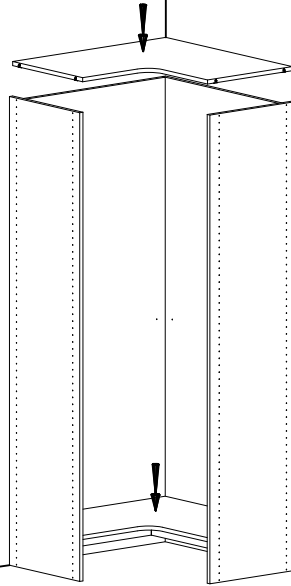
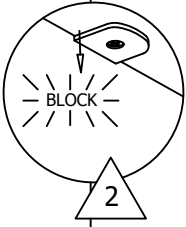
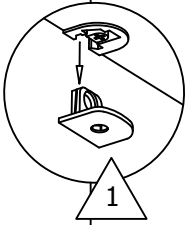
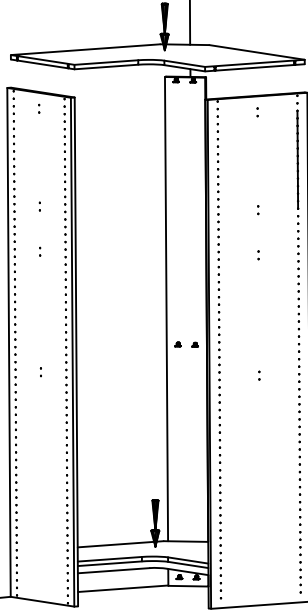

4

TABLETTE FIXE

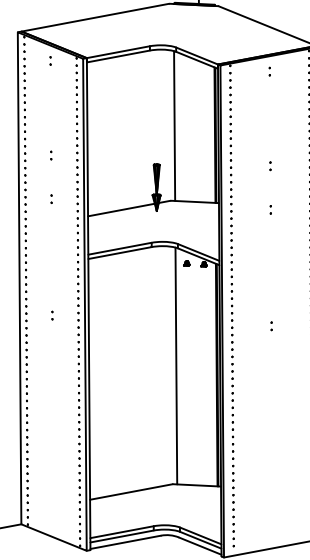
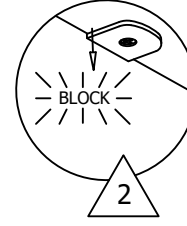
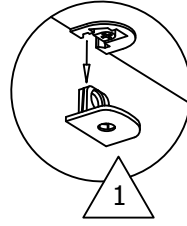

5

PENDERIES

T = COTE DE POSITION TRINGLE

FILEUR SUPPORT D'ANGLE T = 637
FOND D'ANGLE T = 627

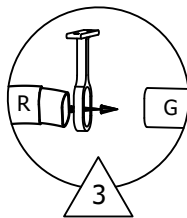
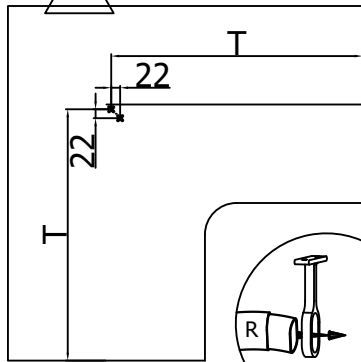
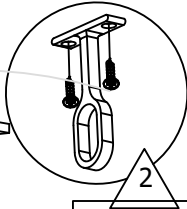
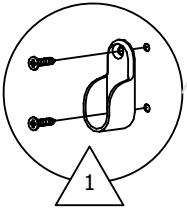
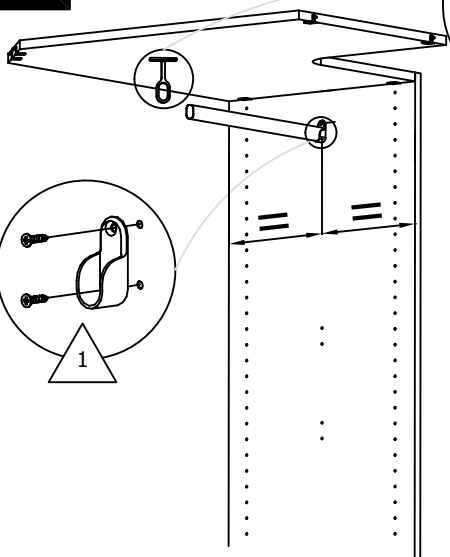

6

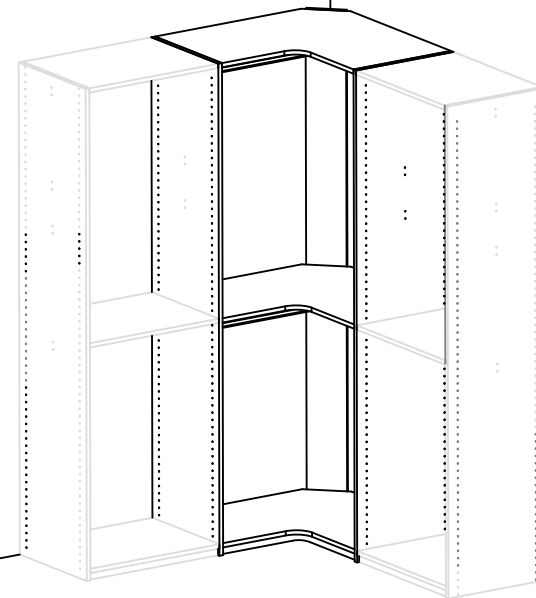

Q



F



G



R



S

