

# SUR-MESURE

NOTICE  
DE POSE  
N° SM1  
FEVRIER 2012

Tablettes plinthes et bandeau pour tout  
l'aménagement, fond 10mm

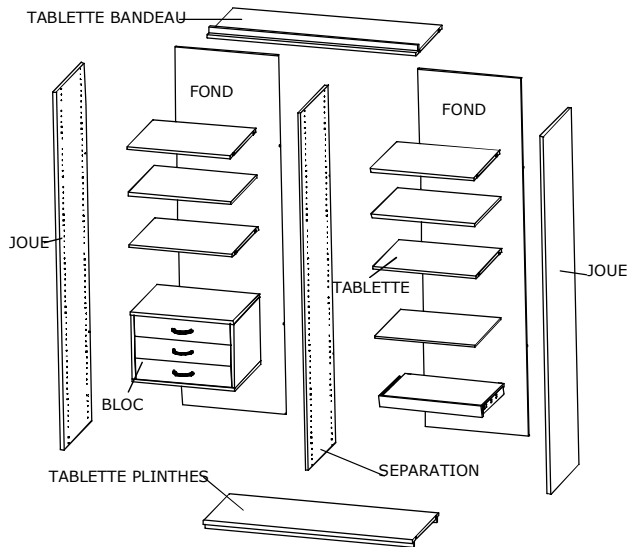
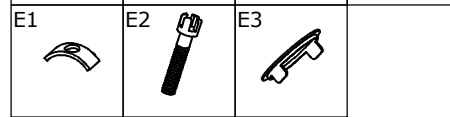
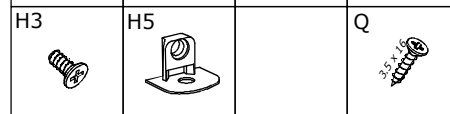
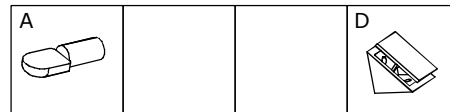
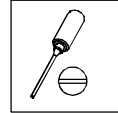
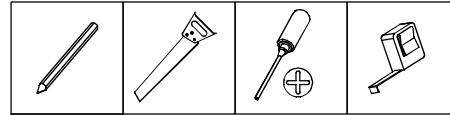
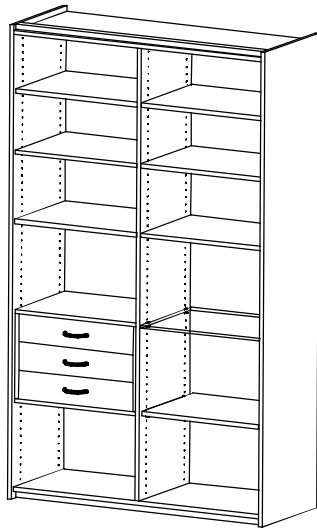

**1**

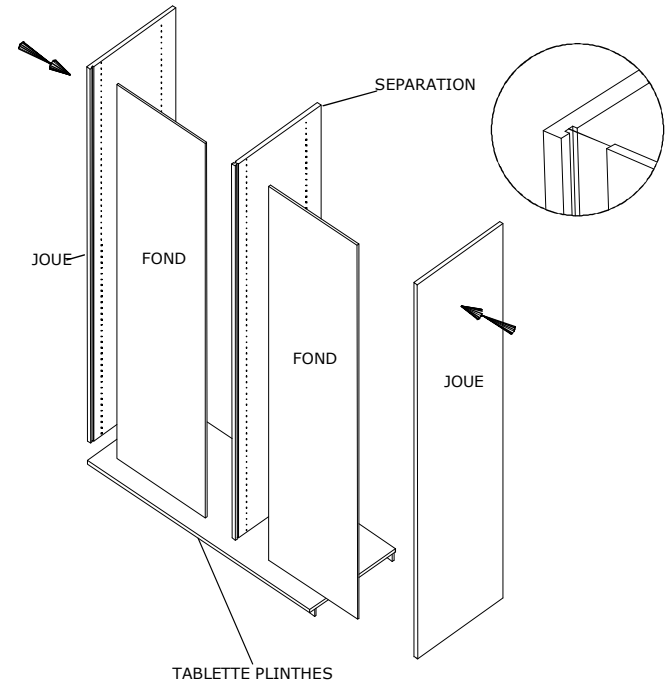

**2**

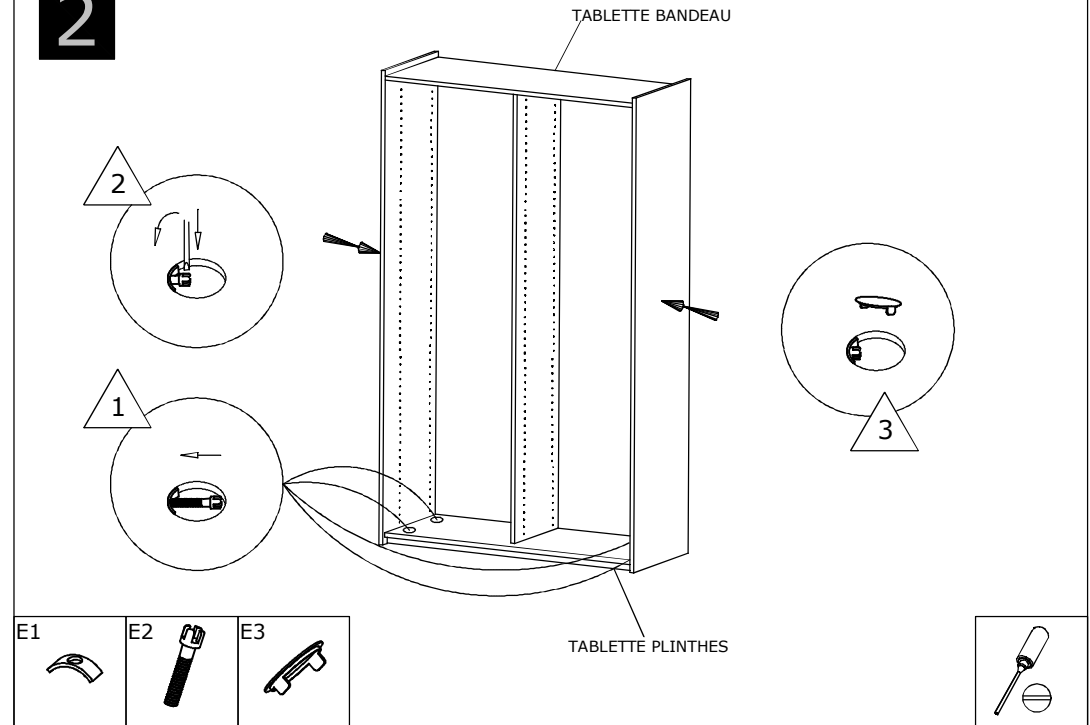

3

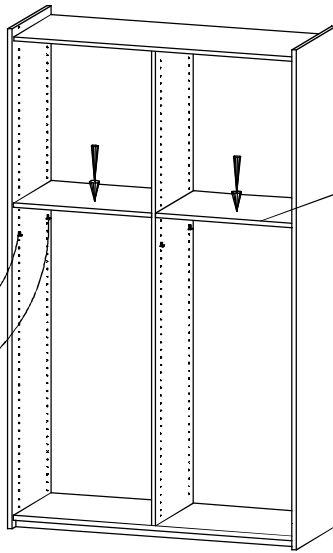
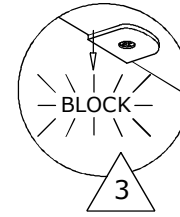
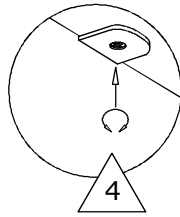
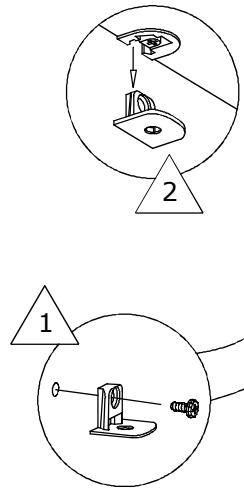

TABLETTE FIXE

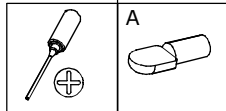
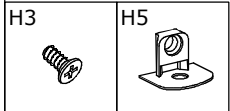

4

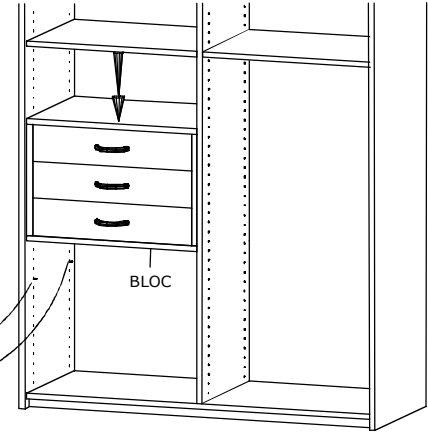
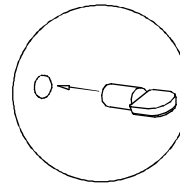
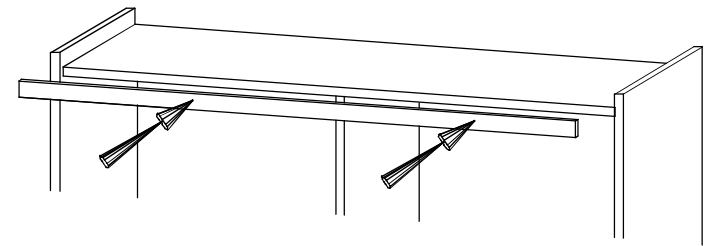

BLOC

5

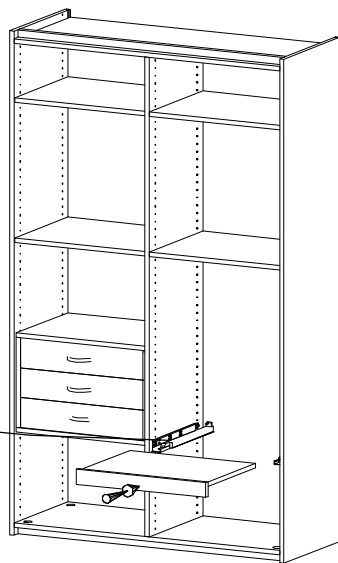
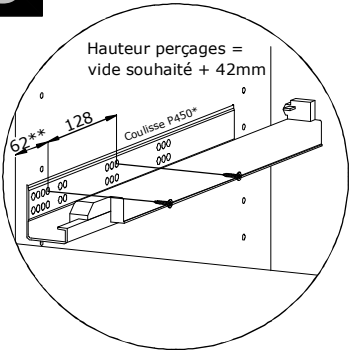

\* Coulisse 270 : AV 62 Entr 96  
 Coulisse 300,350,400,450 : AV 62 Entr 128  
 Coulisse 500,550 : AV 62 Entr 224  
 \*\* Pour un retrait de 5mm (joue / tab)

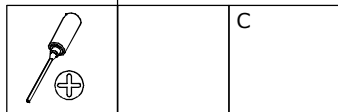
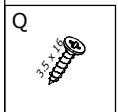

6

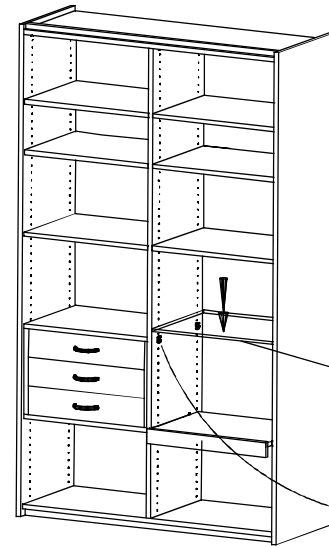

TABLETTE VERRE

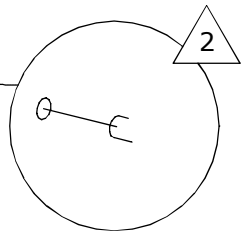

2